

3001-2RS

Angular contact ball bearing

Schaeffler ID:
0008745400000

Angular contact ball bearing 30..-B-2RS-TVH, double row, seals, plastic cage

Technical information

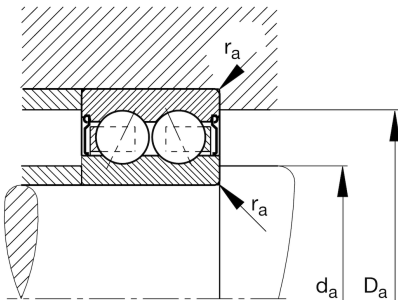
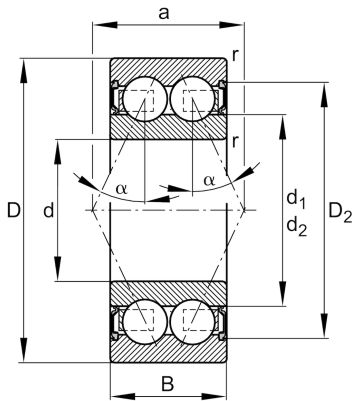

Main Dimensions & Performance Data

d	12 mm	Bore diameter
D	28 mm	Outside diameter
B	12 mm	Width
C_r	6,100 N	Basic dynamic load rating, radial
C_{0r}	3,700 N	Basic static load rating, radial
C_{ur}	193 N	Fatigue load limit, radial
n_G	15,800 1/min	Limiting speed
	0.034 kg	Weight

Dimensions

r_{min}	0.3 mm	Minimum chamfer dimension
D_2	23.2 mm	Caliber diameter outer ring
d_2	16.4 mm	Caliber diameter inner ring
a	13.5 mm	Distance between the apexes of the pressure cones
α	25 °	Contact angle

Mounting dimensions

$d_{a min}$	14 mm	Minimum diameter shaft shoulder
$D_{a max}$	26 mm	Maximum diameter of housing shoulder
$r_{a max}$	0.3 mm	Maximum fillet radius

Temperature range

T_{min}	-20 °C	Operating temperature min.
T_{max}	100 °C	Operating temperature max.